



CANEC24021252908

2024 10 09

1 9

15

COB LED

SGS

GZP24-031628

2024 09 24

2024 09 24 ~ 2024 09 29

| | | | |
|--------|------------|--------|----------------|
| RoHS | 2011/65/EU | II | (EU) 2015/863- |
| (DEHP) | (PBB) | (PBDE) | (2-) |
| (DIBP) | (BBP) | (DBP) | |

Jany Zhong

scan to see the report





CANEC24021252908

2024 10 09

2 9

| | | SGS ID | |
|-----|-----|-------------------------|-----|
| SN1 | A15 | CAN24-0212529-0001.C015 | / / |
| SN2 | A16 | CAN24-0212529-0001.C016 | / |
| SN3 | A17 | CAN24-0212529-0001.C017 | |

(1) 1 mg/kg = 1 ppm = 0.0001%

(2) MDL=

(3) ND = (< MDL)

(4) "-" =

| RoHS | 2011/65/EU | II | (EU) 2015/863- | (PBB) |
|--------|------------|----|----------------|-------|
| (PBDE) | (2- |) | (DEHP) | (BBP) |
| (DBP) | (DIBP) | | | |

IEC 62321-4:2013+AMD1:2017 IEC 62321-5:2013 IEC 62321-7-2:2017 IEC 62321-12:2023 ICP-OES/AAS UV-Vis GC-MS

| | | | MDL | A15 | A16 |
|-----------|------|-------|-----|-----|-----|
| (Pb) | 1000 | mg/kg | 2 | ND | ND |
| (Hg) | 1000 | mg/kg | 2 | ND | ND |
| (Cd) | 100 | mg/kg | 2 | ND | ND |
| (Cr(VI)) | 1000 | mg/kg | 8 | ND | ND |
| (PBB) | 1000 | mg/kg | - | ND | ND |
| (MonoBB) | - | mg/kg | 25 | ND | ND |
| (DiBB) | - | mg/kg | 25 | ND | ND |
| (TriBB) | - | mg/kg | 25 | ND | ND |
| (TetraBB) | - | mg/kg | 25 | ND | ND |
| (PentaBB) | - | mg/kg | 25 | ND | ND |



CANEC24021252908

2024 10 09

3 9

| | | | MDL | A15 | A16 |
|------------|---|-------|-----|-----|-----|
| (HexaBDE) | - | mg/kg | 25 | ND | ND |
| (HeptaBDE) | - | mg/kg | 25 | ND | ND |
| (OctaBDE) | - | mg/kg | 25 | ND | ND |
| (NonaBDE) | - | mg/kg | 25 | ND | ND |
| (DecaBDE) | - | mg/kg | 25 | ND | ND |

(2-



CANEC24021252908

2024 10 09

4 9

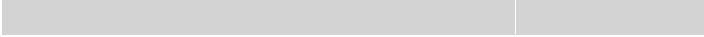

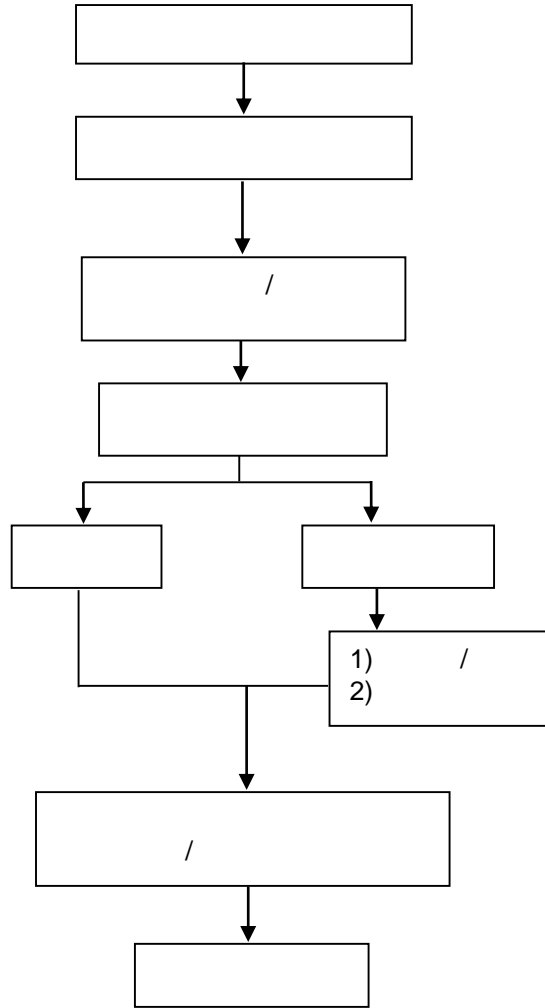

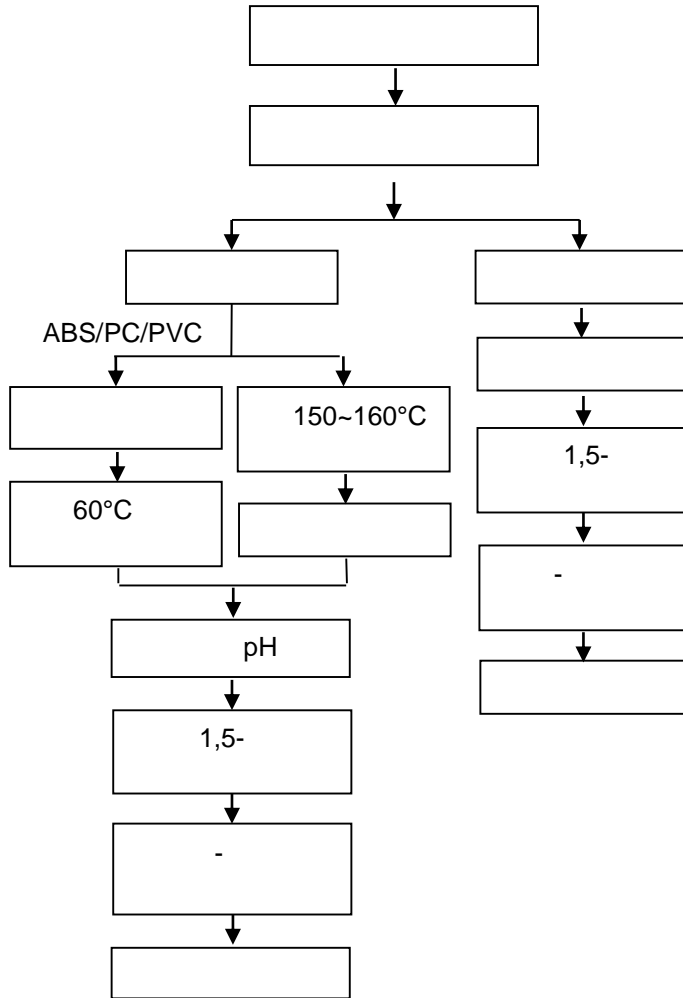



PBB/PBDE/Phthalates

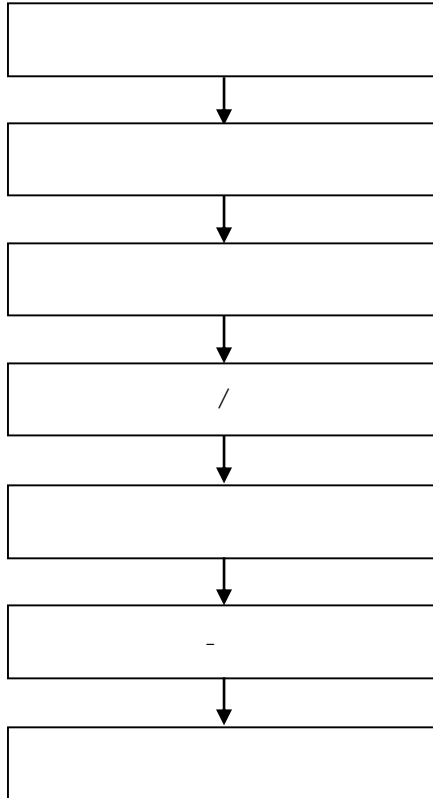

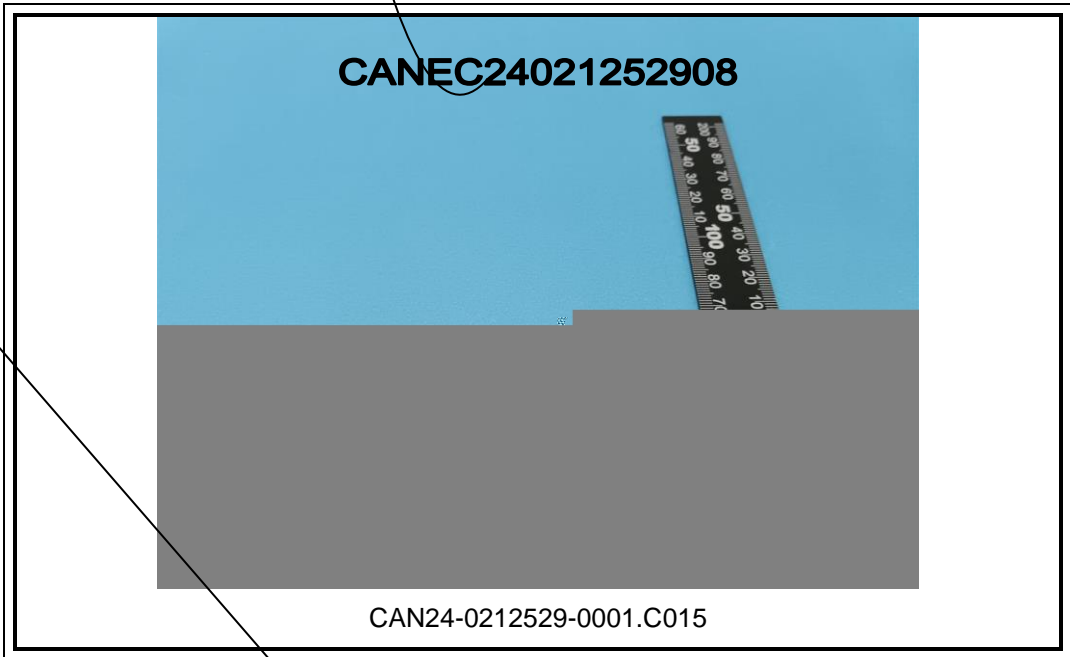

CAN24-0212529-0001.C015

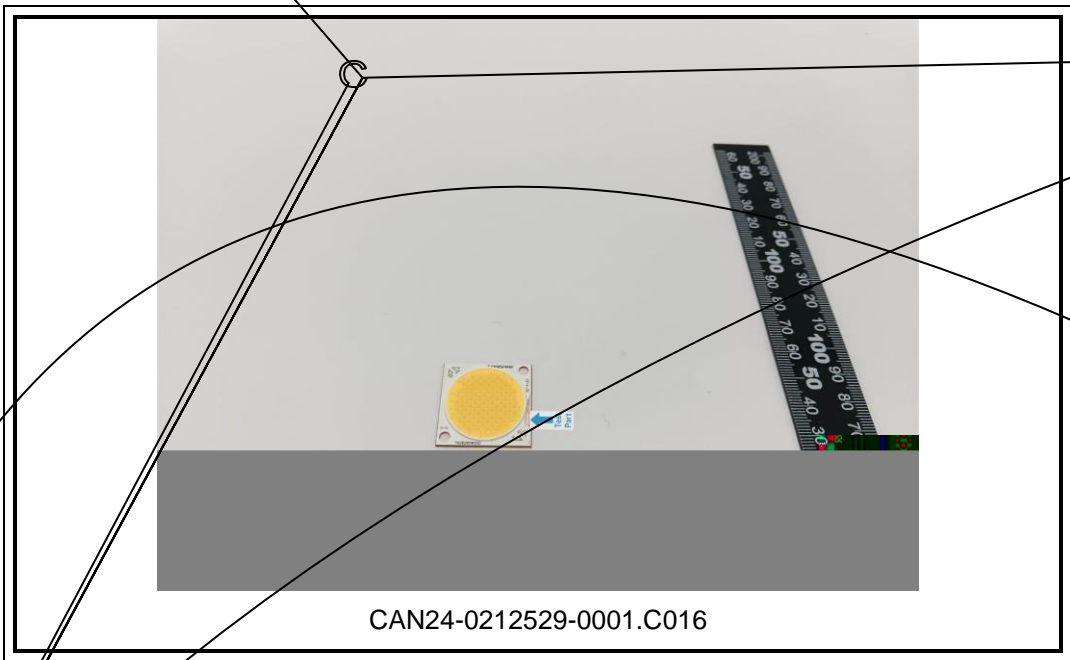

CAN24-0212529-0001.C016



CANEC24021252908

2024 10 09

9

9

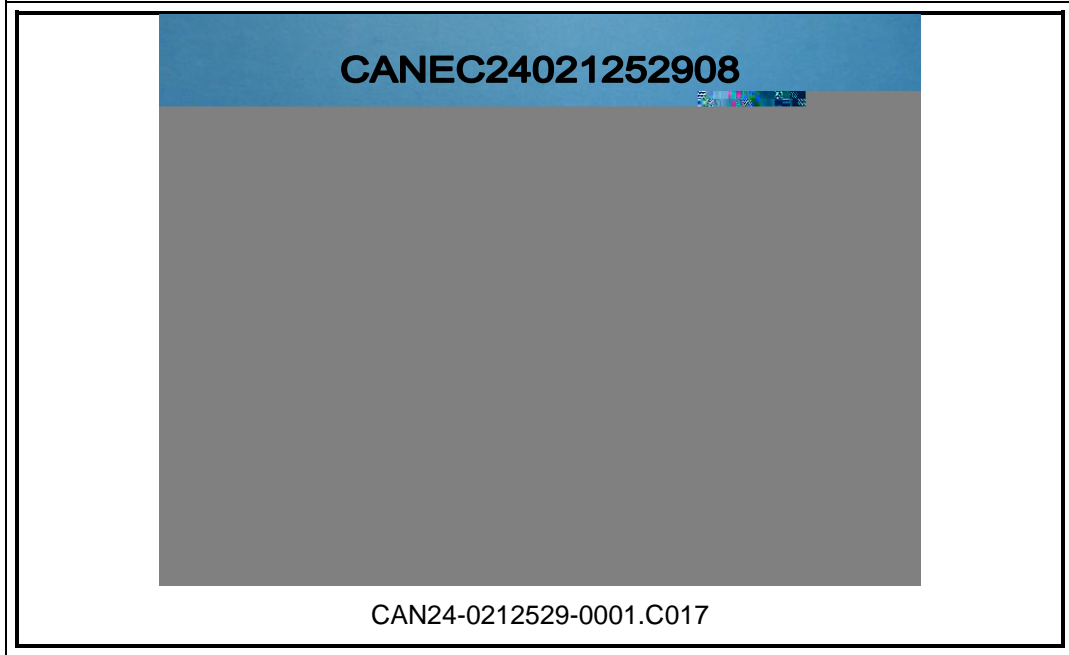

SGS
