

TX-4045W12VCA1-NP3CD-02H95

PRODUCT SPECIFICATION

Features:

Chip Material:

Emitting Color:

Applications:

--	--	--	--	--	--

Package Dimensions:

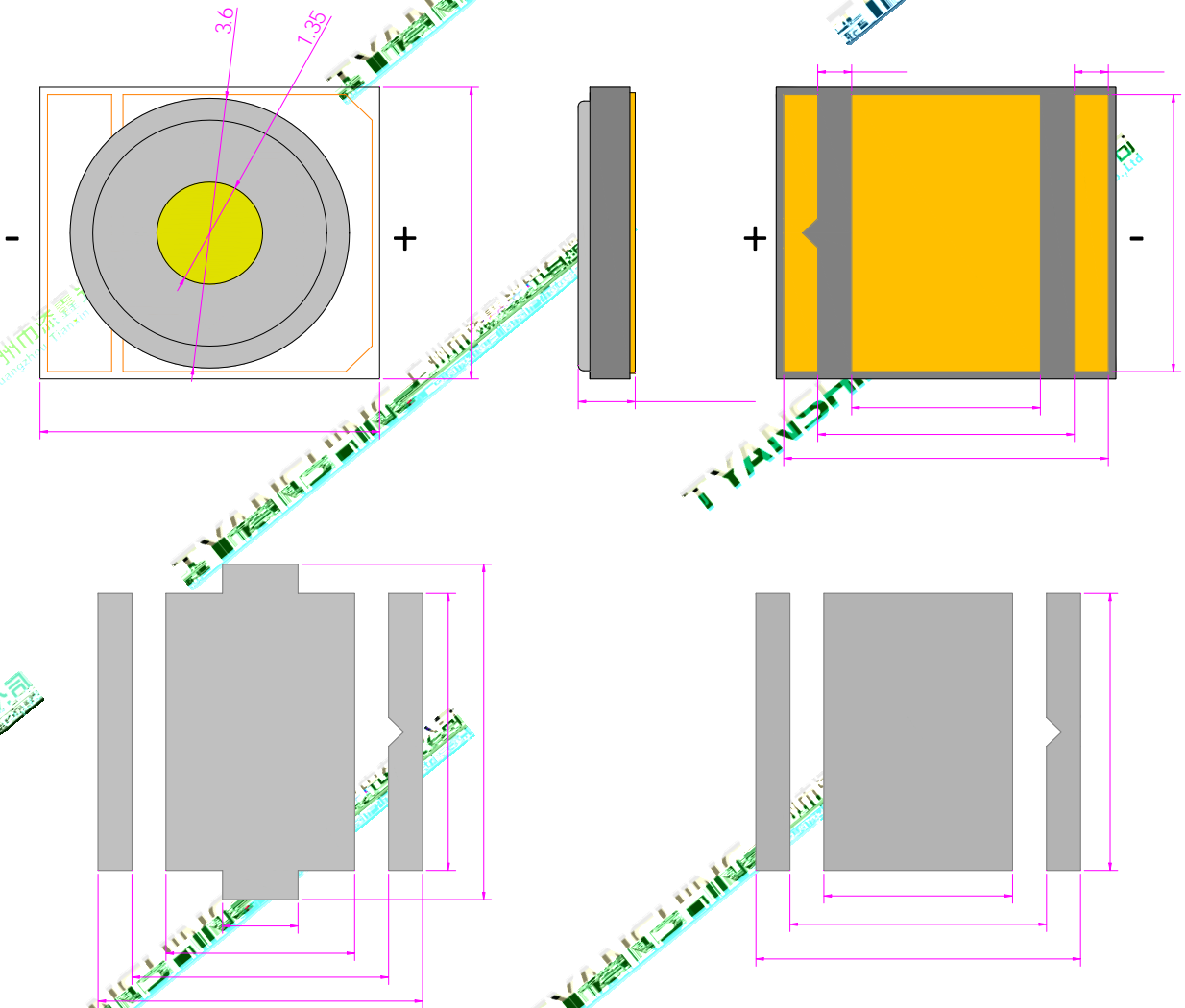

Notes:

--	--	--	--	--	--

Absolute Maximum Ratings (Tc=25)

Parameter	Symbol	Ratings	Unit

Notes:

--	--	--	--	--	--

Typical Electrical/Optical Characteristics Curves(IF=1A)

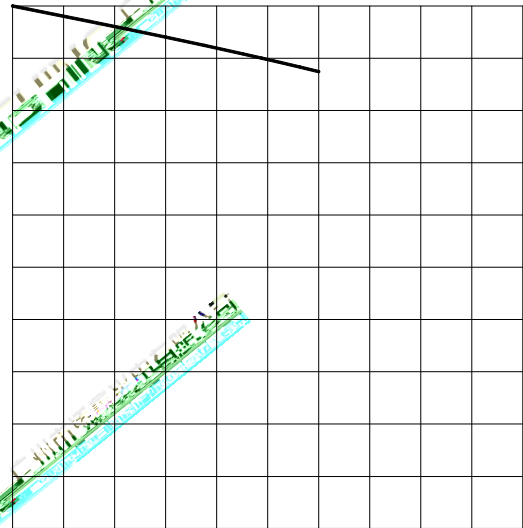
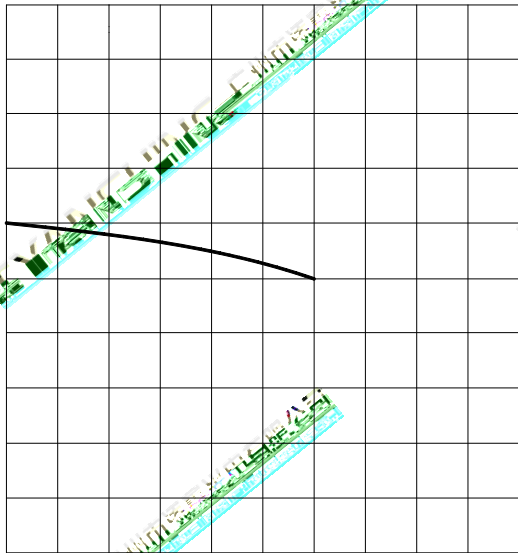
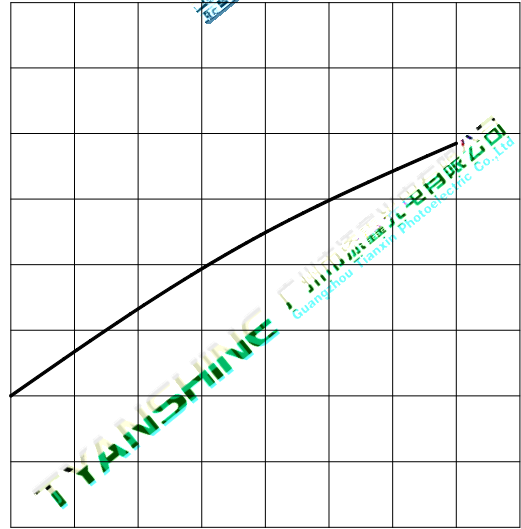
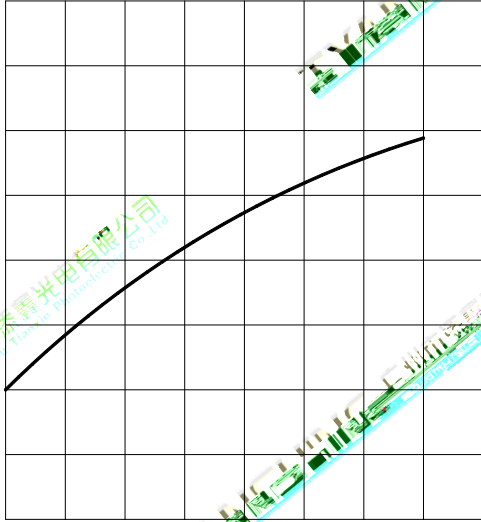

--	--	--	--	--	--

Usage Precautions

Storage Environment Condition

Soldering Condition



--	--	--	--	--	--

Dimensions For Cannulation And Packaging

Quantity:1000PCS

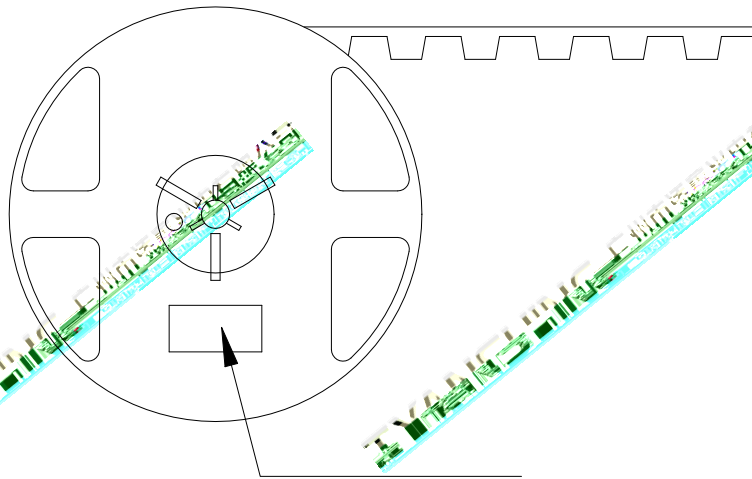
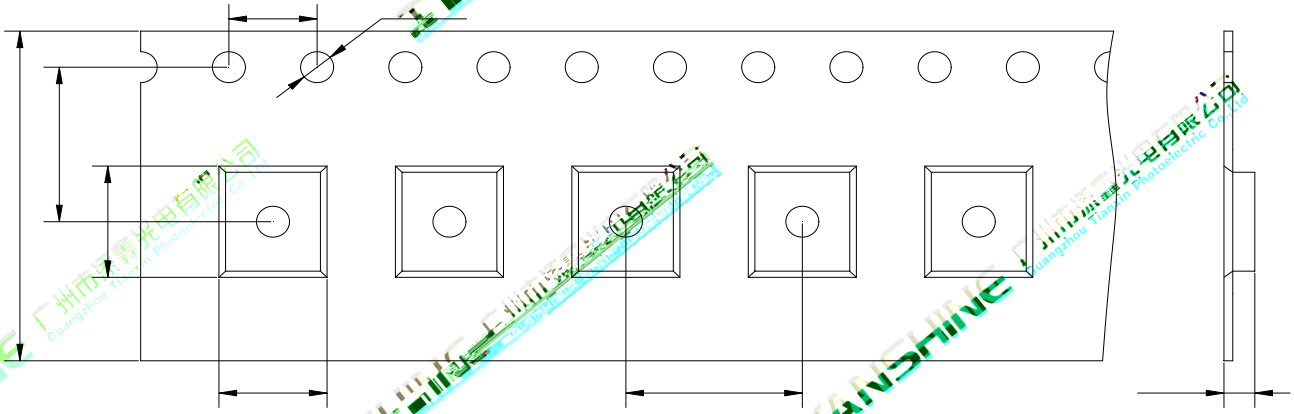

Notes:

--	--	--	--	--	--