

TX-3535RGBW8VSD1-NG4DC-01

PRODUCT SPECIFICATION

Features :

Chip Material:

Emitting Color:

Application :

--	--	--	--	--	--

Package Dimension :

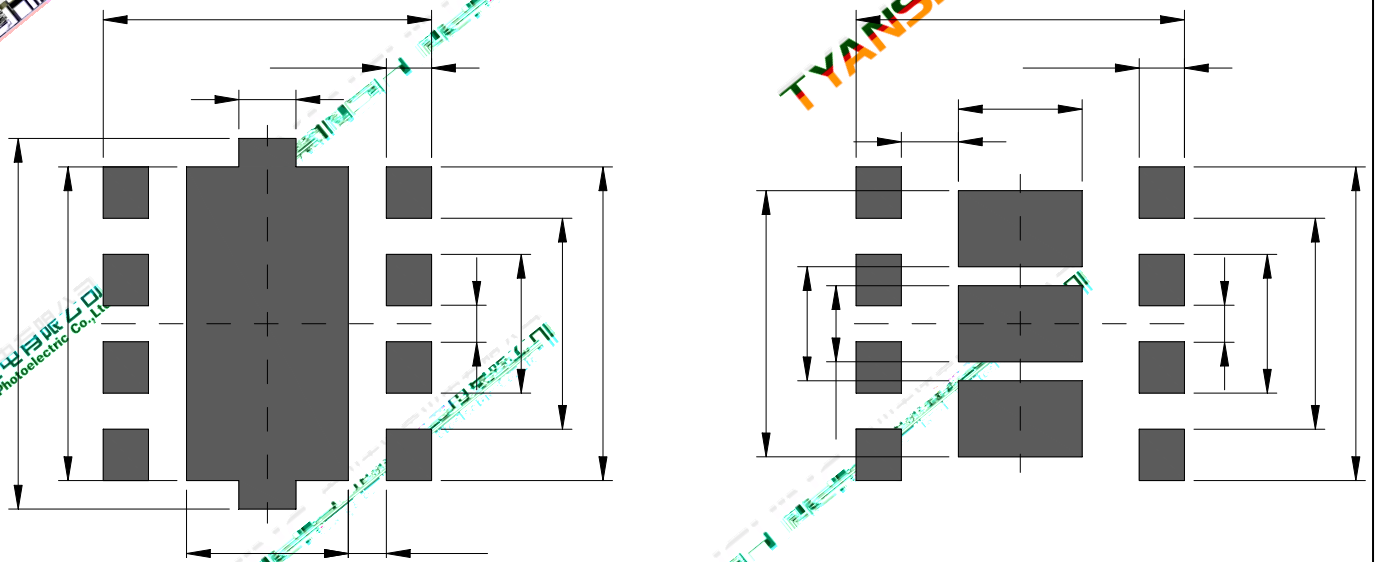
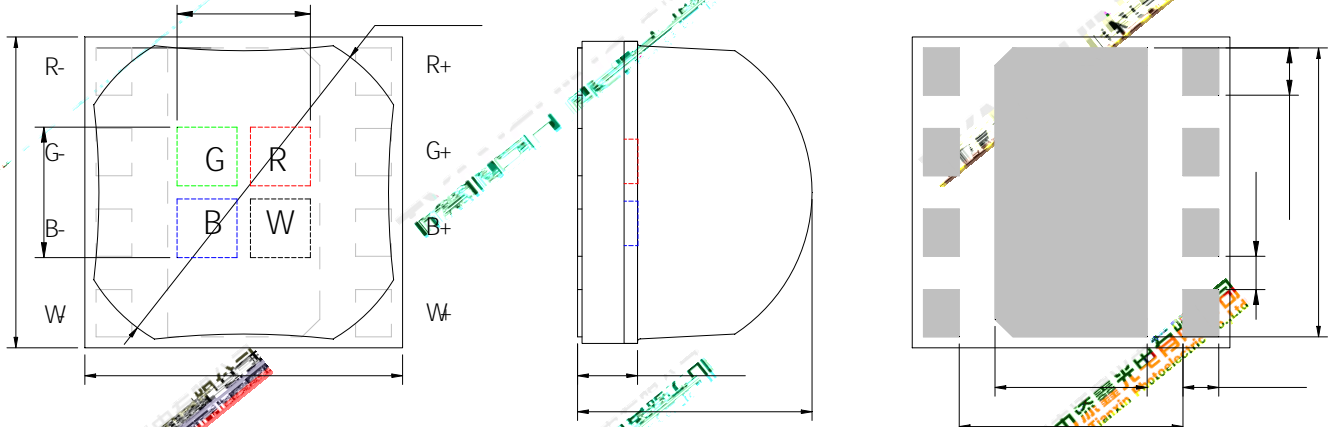

No e :

--	--	--	--	--	--

Abol e Ma im m Ra ing (Tc=25)

Parame er	S mbol	Ma Ra ing	Uni		
<div data-bbox="89 622 403 981" style="float: left; width: 20%;"> </div>	<div data-bbox="363 622 850 1025" style="float: left; width: 20%;"> </div>	<div data-bbox="896 555 1385 958" style="float: left; width: 20%;"> </div>			
<p data-bbox="89 1608 199 1646">No e :</p>					

Electrical Optical Characteristics (Tc=25°C IF=500mA)

Parameter	Symbol	Emitting Color	Min.	Typ.	Max.	Unit

Note:

Typical Electrical/Optical Characteristic Curve

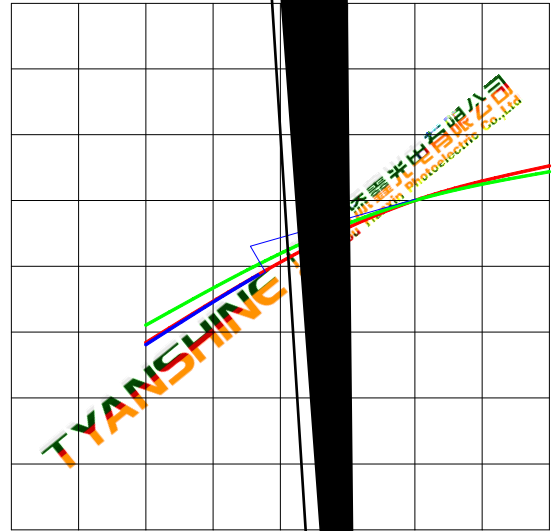
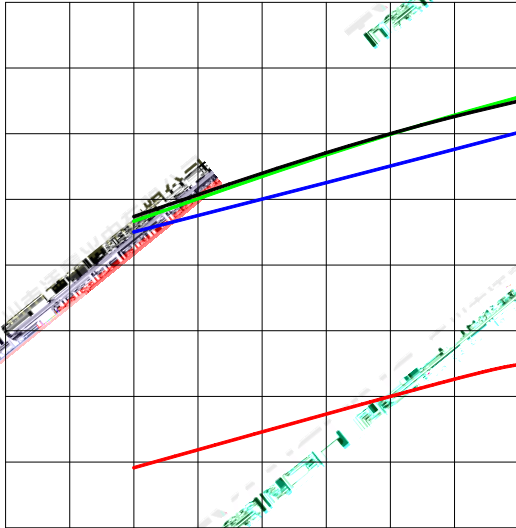

Usage Precaution

Storage Environment Condition

Soldering Condition

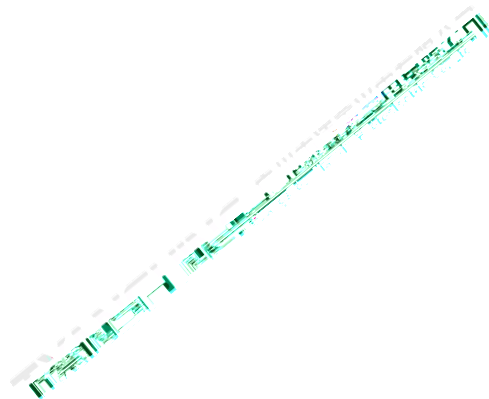
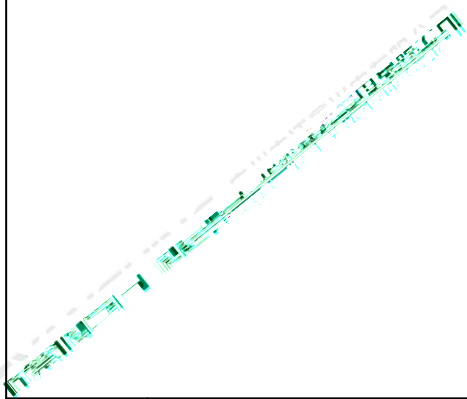
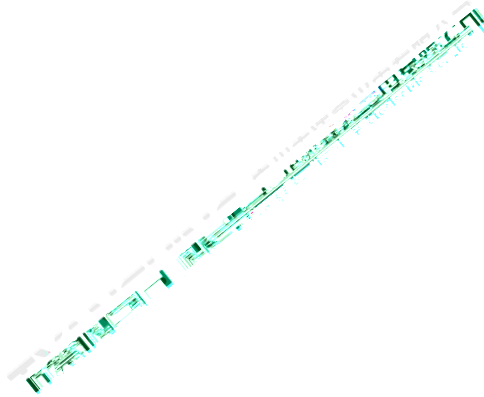
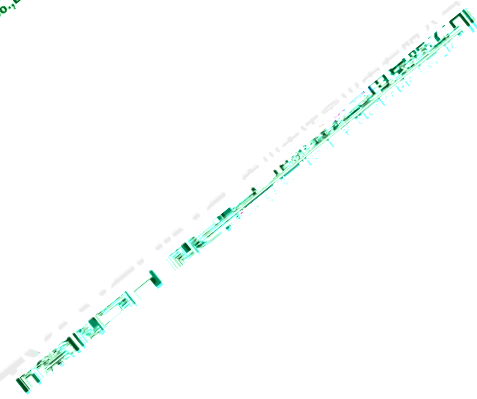
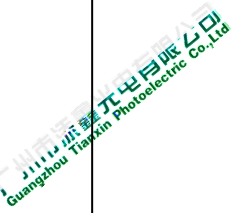
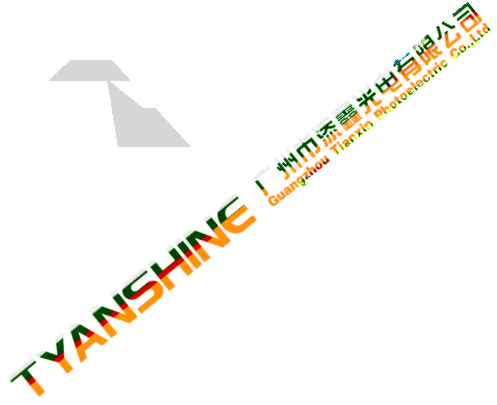
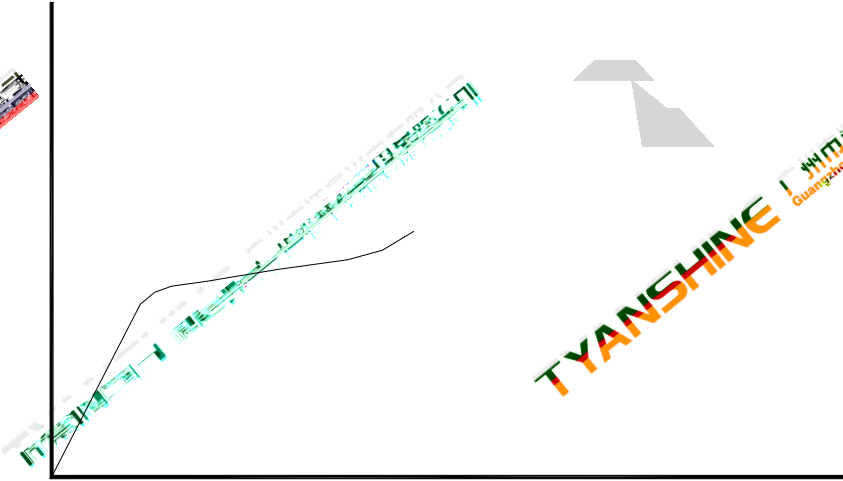
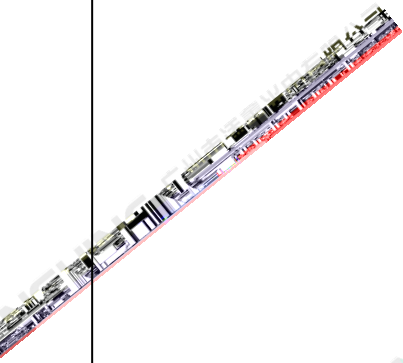

--	--	--	--	--	--

nd Packaging

