

LED

SGS

GZP23-013561

2023 09 13

2023 09 13 ~ 2023 09 21

RoHS 2011/65/EU		II	(EU) 2015/863-
(PBBs)	(BBP)	(PBDEs)	(DBP)
(DIBP)		(2-) (DEHP)



Jessie-JX Li

scan to see the report



49121561

		SGS ID	
SN1	A1	CAN23-0098898-0001.C001	
SN2	A2	CAN23-0098898-0001.C002	,
SN3	A3	CAN23-0098898-0001.C003	
SN4	A4	CAN23-0098898-0001.C004	,
SN5	A5	CAN23-0098898-0001.C005	
SN6	A6	CAN23-0098898-0001.C006	,

(1) 1 mg/kg = 1 ppm = 0.0001%

(2) MDL=

(3) ND = (< MDL)

(4) "-" =

RoHS	2011/65/EU	II	(EU) 2015/863-	(PBBs)
(PBDEs)	(DBP)	(BBP)	(2-)
(DEHP)	(DIBP)			

IEC 62321-4:2013+AMD1:2017 IEC 62321-5:2013 IEC 62321-7-2:2017 IEC
62321-6:2015 IEC 62321-8:2017 ICP-OES UV-Vis GC-MS

			MDL	A1	A2	A3
(Cd)	100	mg/kg	2	ND	ND	ND
(Pb)	1000	mg/kg	2	ND	19	ND
(Hg)	1000	mg/kg	2	ND	ND	ND
(Cr(VI))	1000	mg/kg	8	ND	ND	ND
(PBBs)	1000	mg/kg	-	ND	ND	ND
(MonoBB)	-	mg/kg	5	ND	ND	ND
(DiBB)	-	mg/kg	5	ND	ND	ND
(TriBB)	-	mg/kg	5	ND	ND	ND
(TetraBB)	-	mg/kg	5	ND	ND	ND
(PentaBB)	-	mg/kg	5	ND	ND	ND
(HexaBB)	-	mg/kg	5	ND	ND	ND
(HeptaBB)	-	mg/kg	5	ND	ND	ND
(OctaBB)	-	mg/kg	5	ND	ND	ND
(NonaBB)	-	mg/kg	5	ND	ND	ND
(DecaBB)	-	mg/kg	5	ND	ND	ND



Unless otherwise agreed in writing, this document is issued by the Company subject to its General Conditions of Service printed overleaf



			MDL	A1	A2	A3
(PBDEs)	1000	mg/kg	-	ND	ND	ND
(MonoBDE)	-	mg/kg	5	ND	ND	ND
(DiBDE)	-	mg/kg	5	ND	ND	ND



			MDL	A4	A5	A6
(DBP)	1000	mg/kg	50	ND	ND	ND
(BBP)	1000	mg/kg	50	ND	ND	ND
(2-) (DEHP)	1000	mg/kg	50	ND	ND	ND
(DIBP)	1000	mg/kg	50	ND	ND	ND

- (1) RoHS (EU) 2015/863
- (2) IEC 62321 EN 62321
- (3) 2021 7 22 DEHP BBP DBP DIBP

ILAC-G8:09/2019

w=0

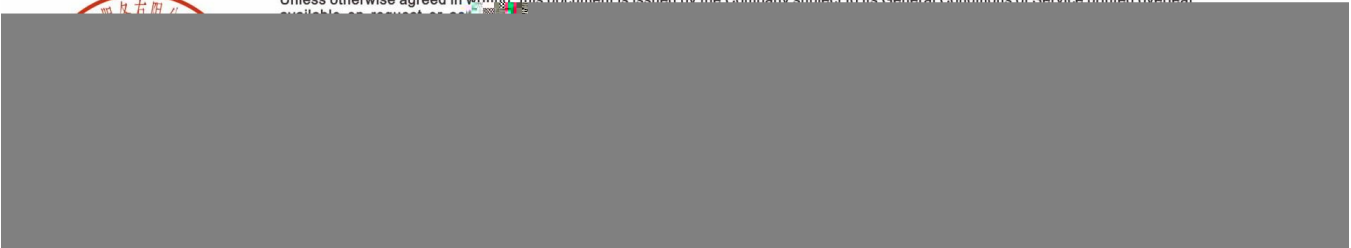

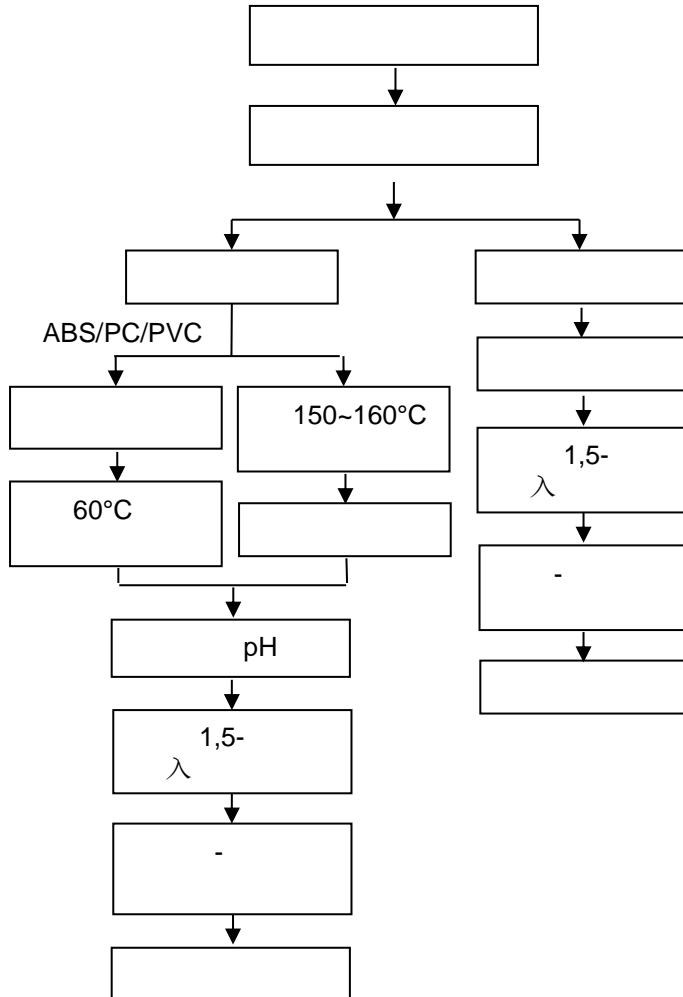

PBBs/PBDEs

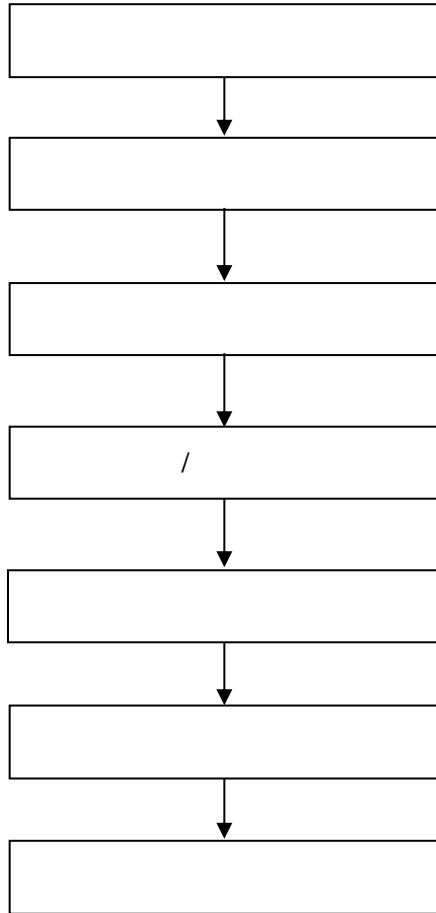

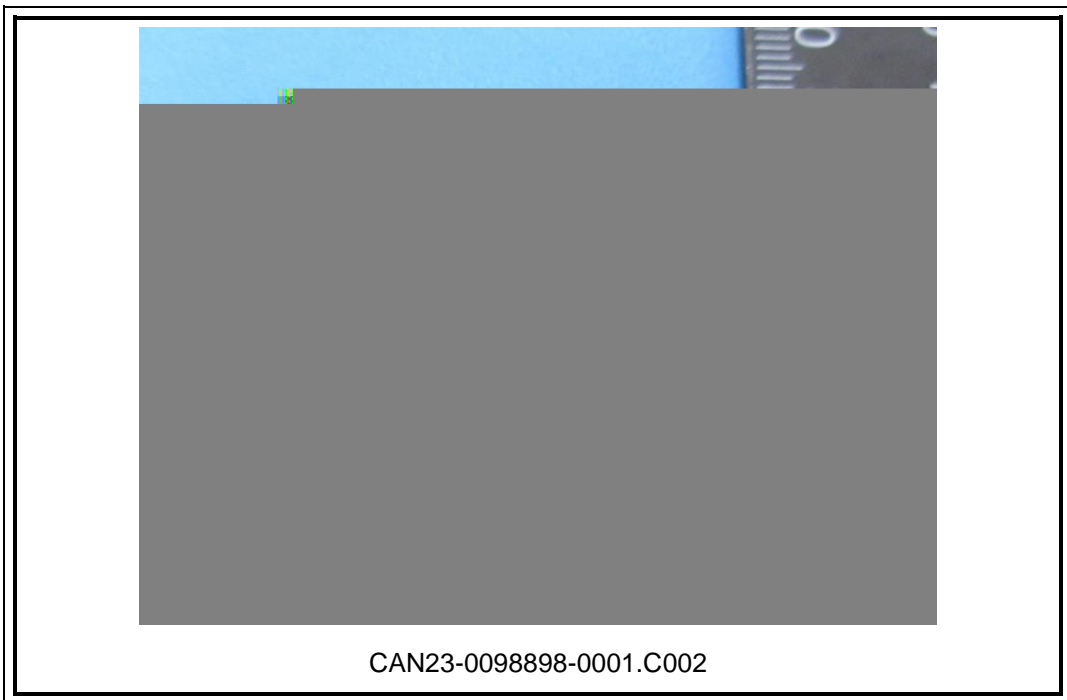
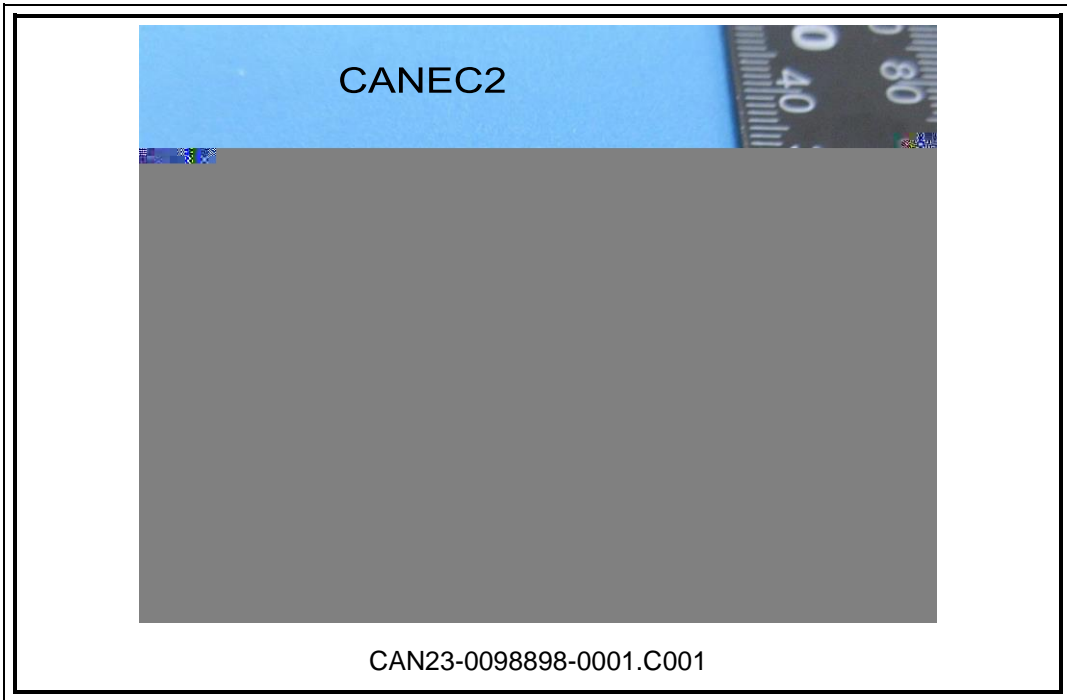

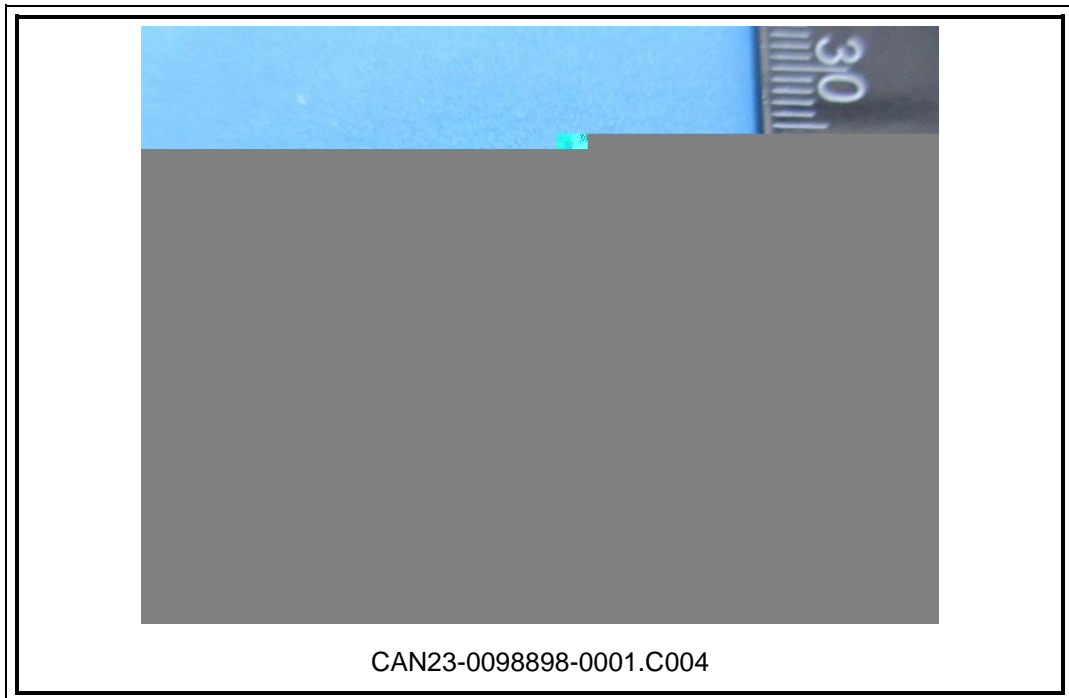
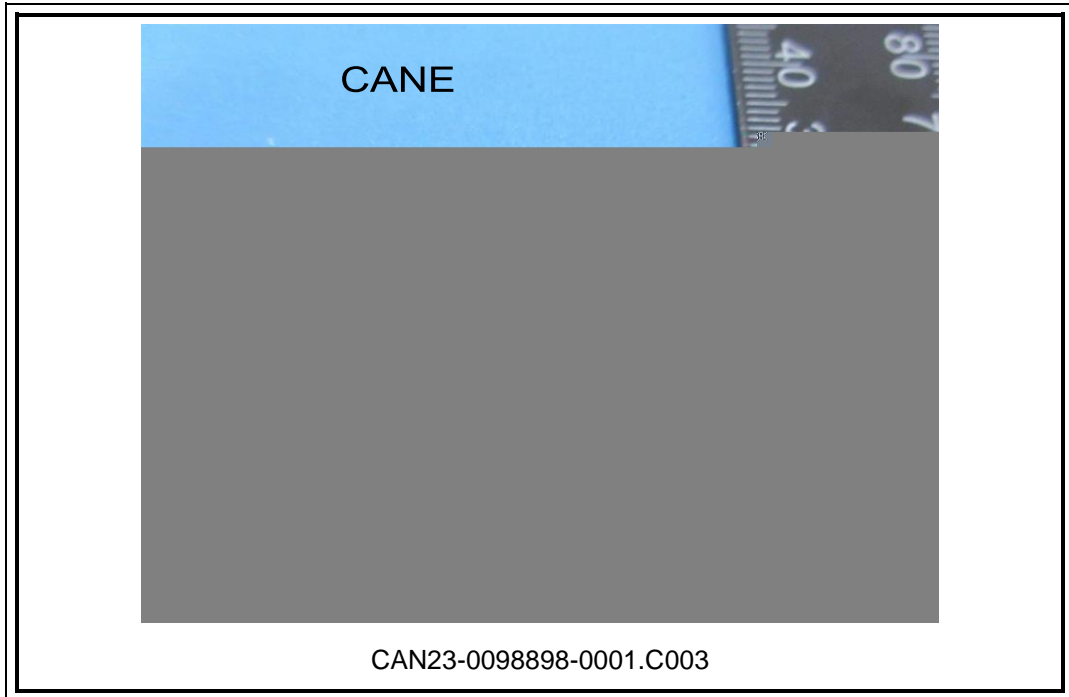

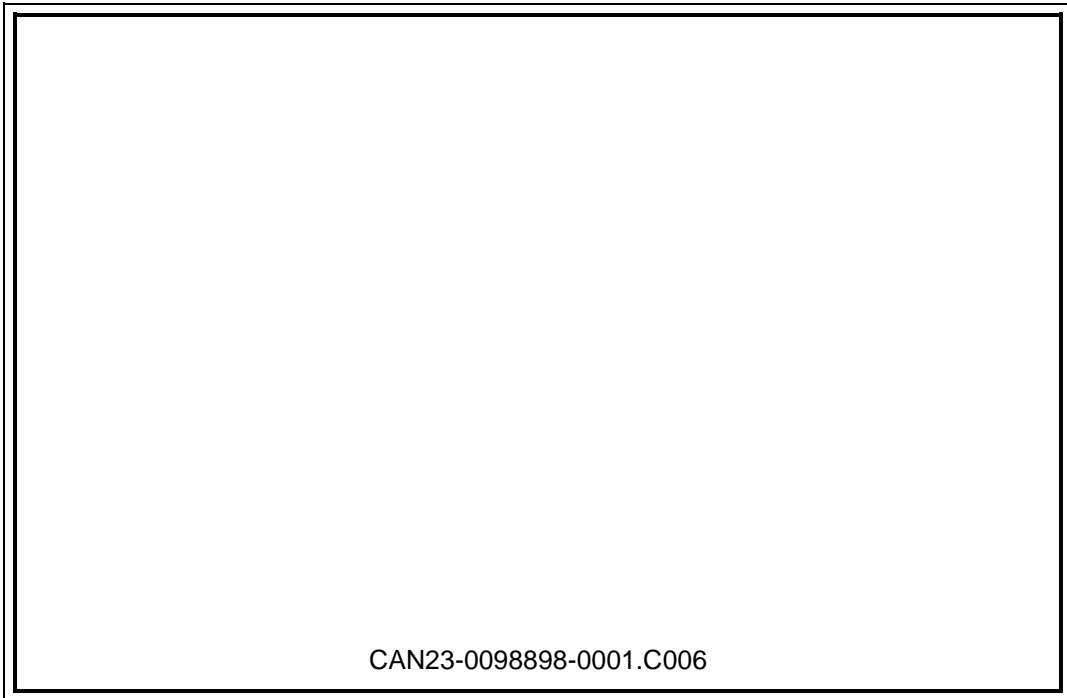
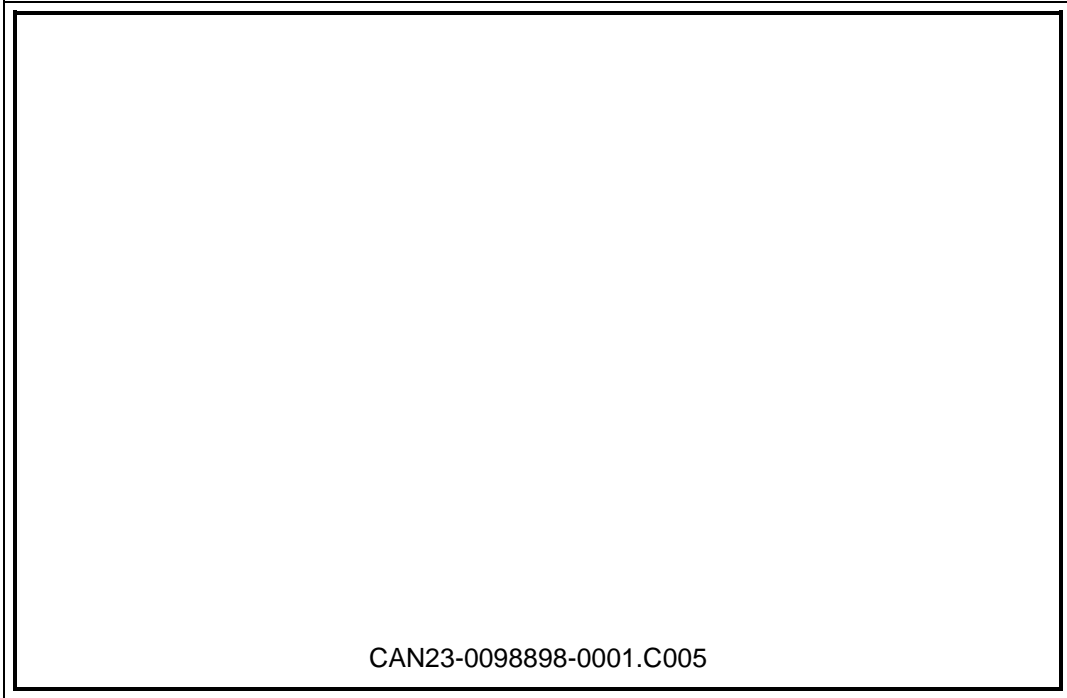

SGS

